

標準横断面図 (1) 敷津東南北線

S=1:100

断面 1-1



断面 2-2

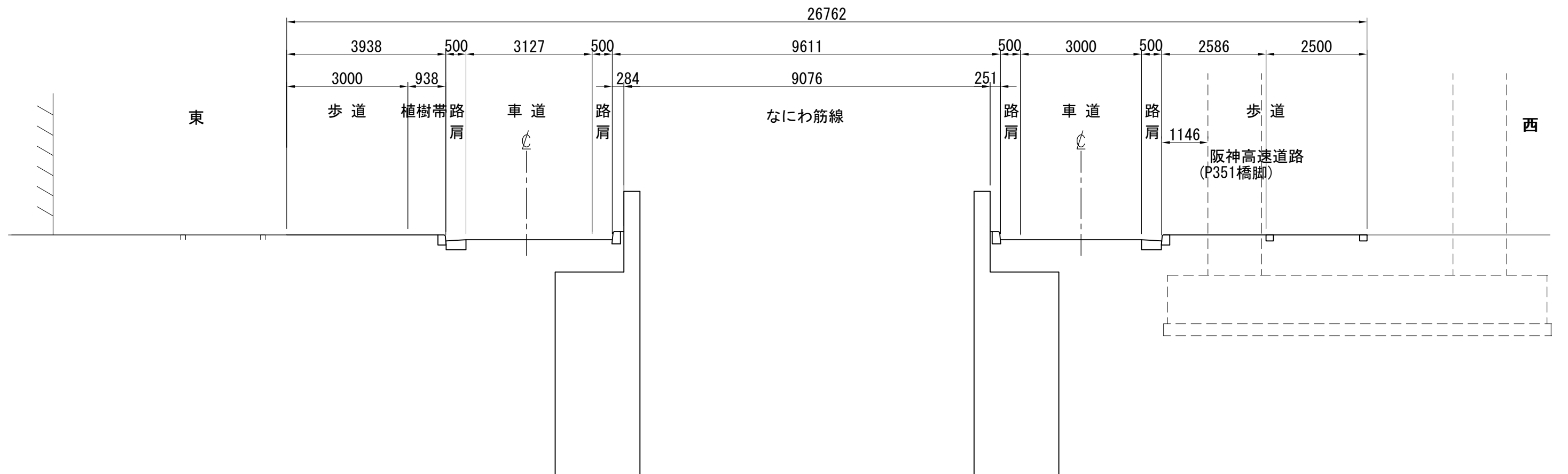

標準横断面図 (2) 敷津東南北線

S=1:100

断面 3-3

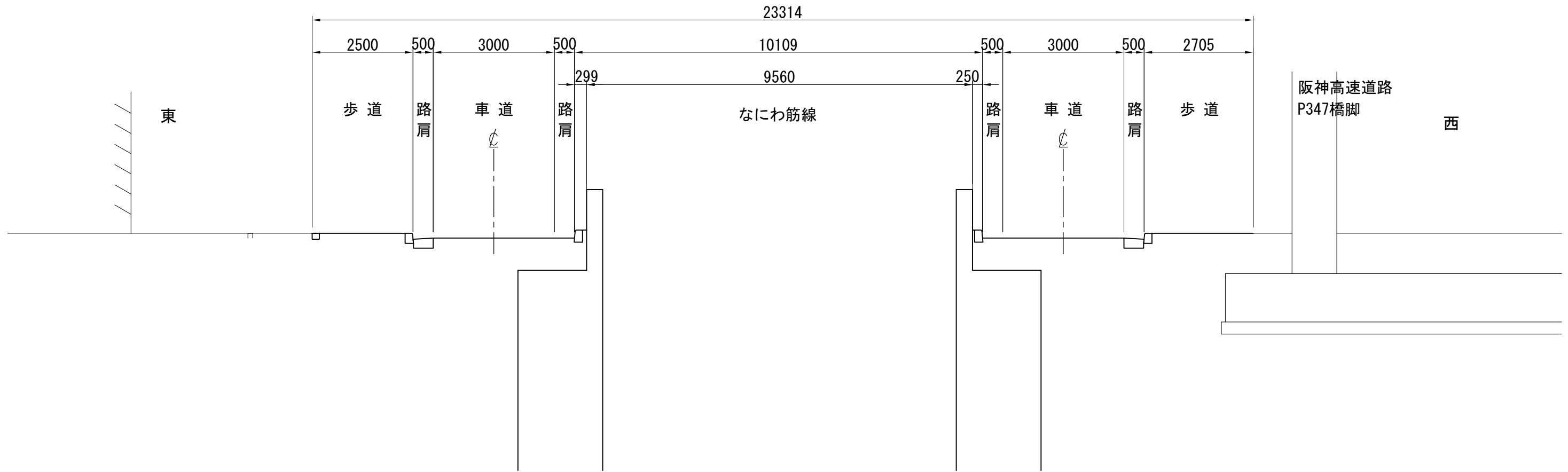

断面 4-4

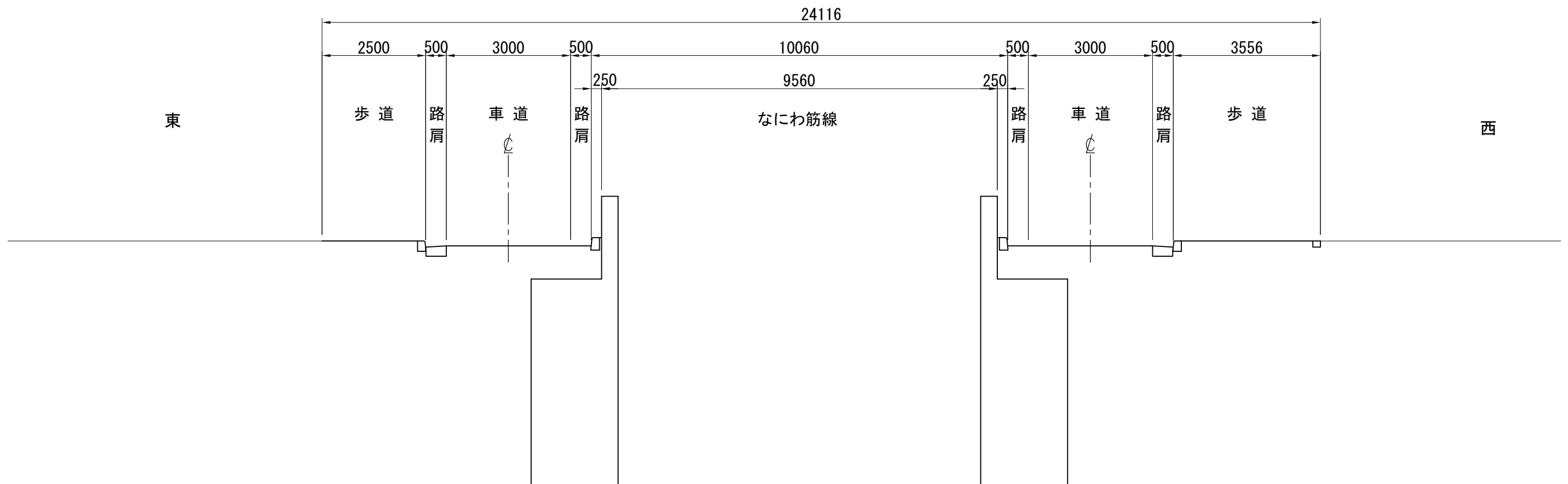

断面 5-5

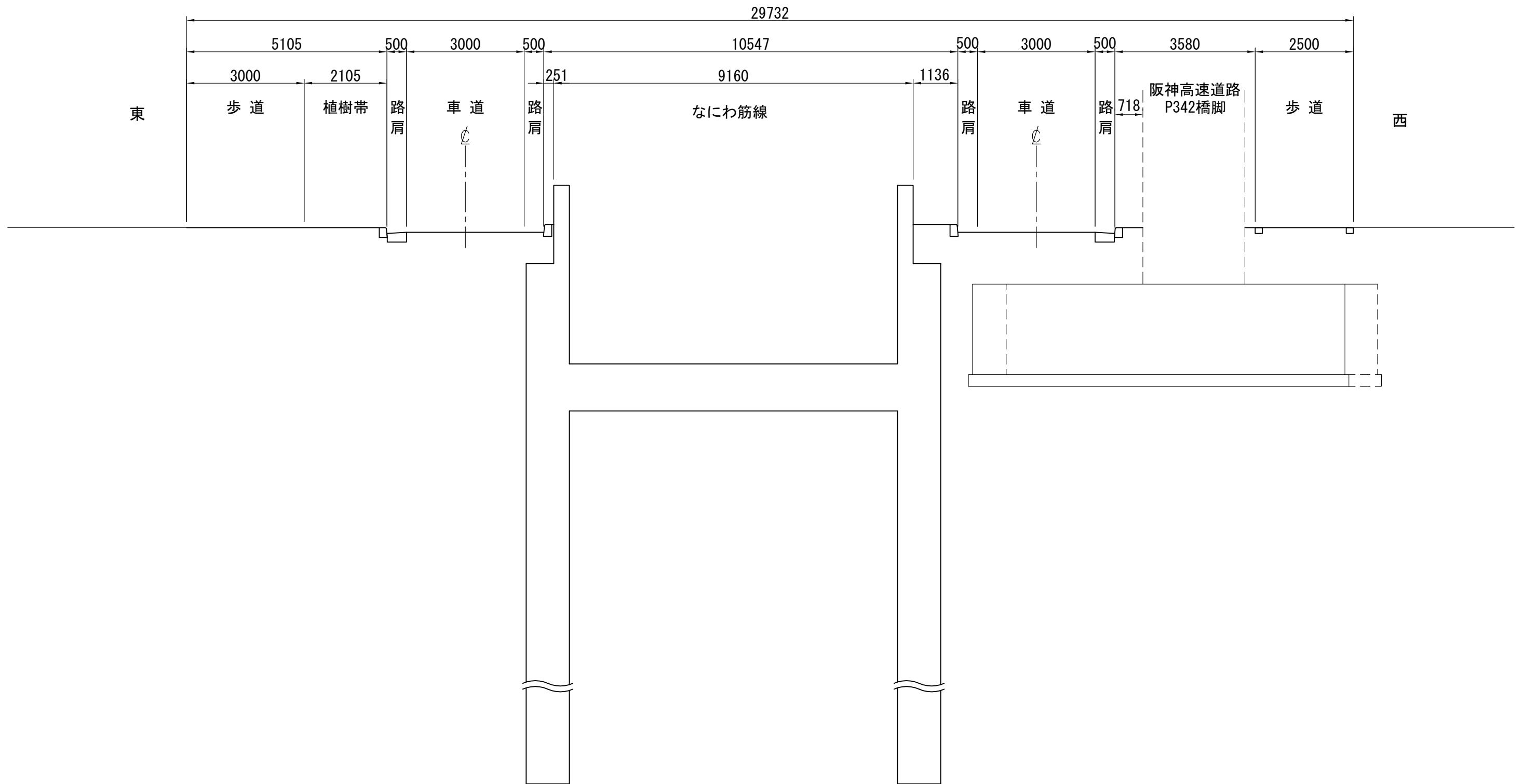

断面 6-6

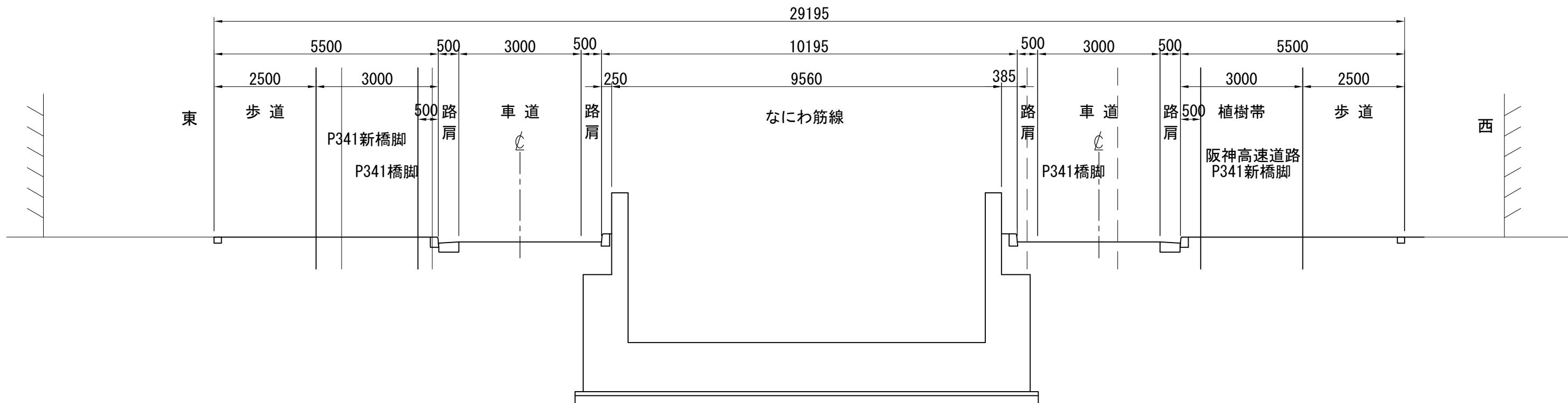

断面 7-7

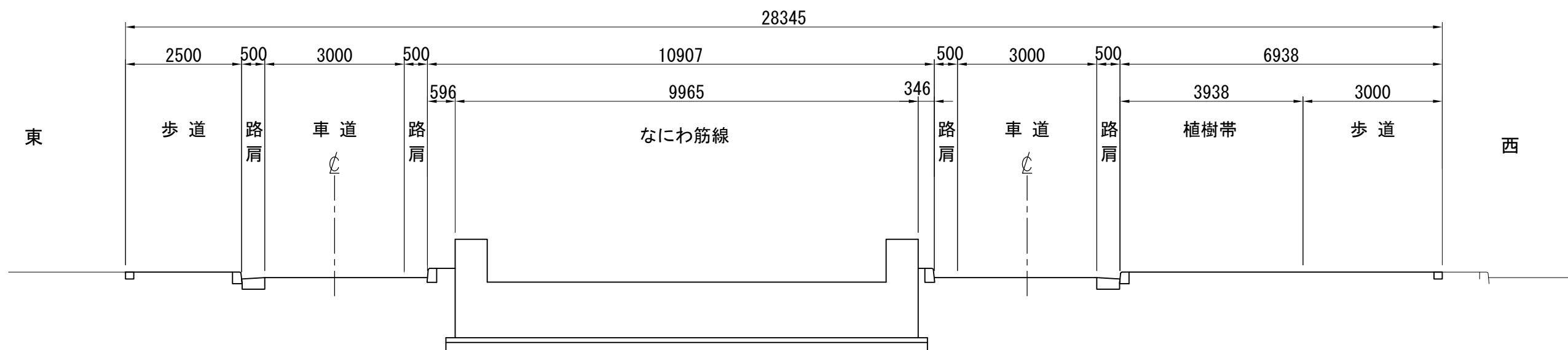

標準横断面図 (5) 敷津東南北線

S=1:100

断面 8-8

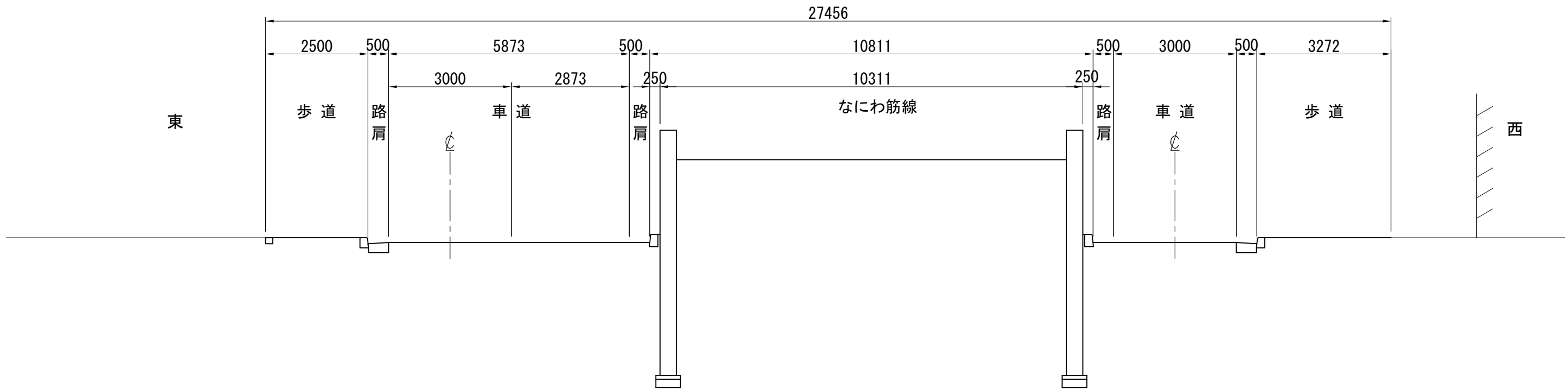

断面 9-9

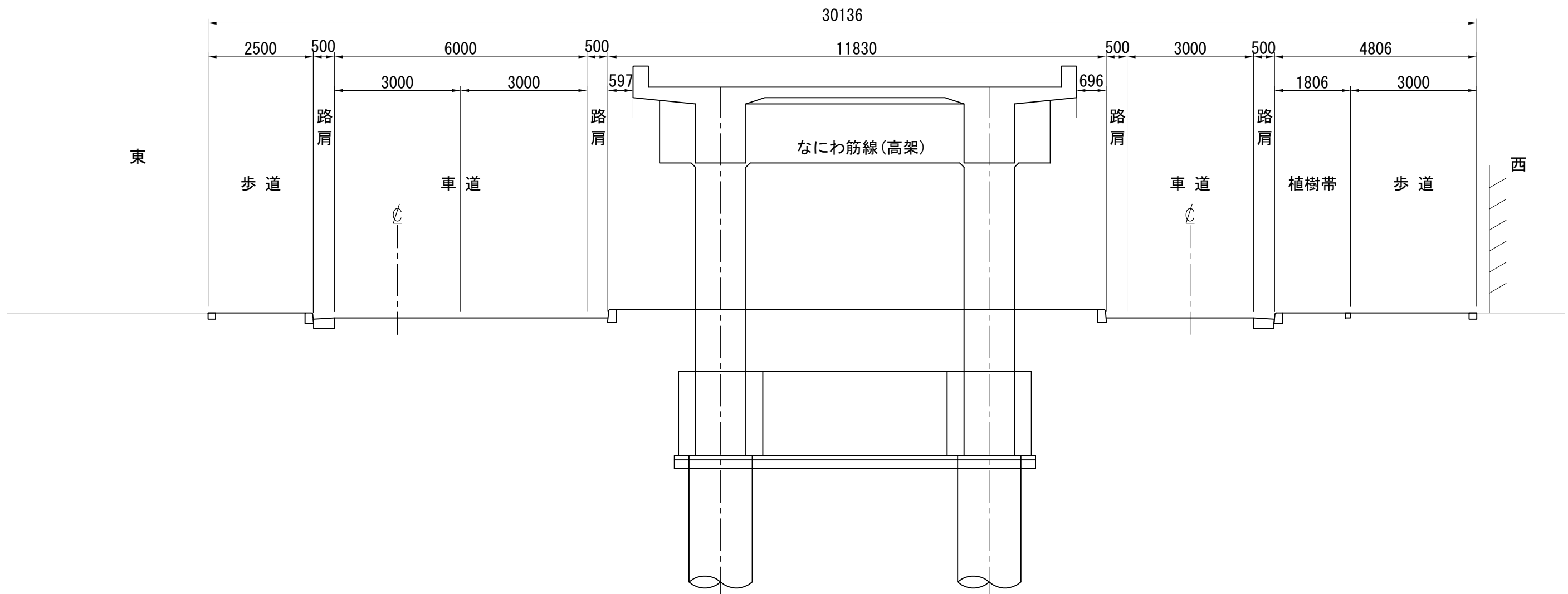

断面 10-10

